

COMPLETE FAN RANGE

Designed for comfort, built for cool!

by
synerji
ELECTRICAL

INDUSTRIAL FLOOR FAN

INTRODUCTION

The Synerji Industrial Floor Fan delivers strong, consistent airflow for larger commercial and industrial areas. Its durable metal build ensures reliable performance, while the adjustable stand and robust motor provide effective ventilation wherever needed. A sturdy, versatile choice for demanding environments requiring powerful and dependable air circulation across workshops, warehouses, factories, and large open spaces.

INDUSTRIAL FLOOR FAN 2 BLADE - 230W

SYF26F

Airflow (m³/H) : 205m³/min

Blades: 2 Blades

Material: Metal

Input Voltage: AC220V – 240V 50HZ

Power: 230W

RPM: 1400 Max

Diameter: Ø720mm

Height of stand: 1188 – 1588mm

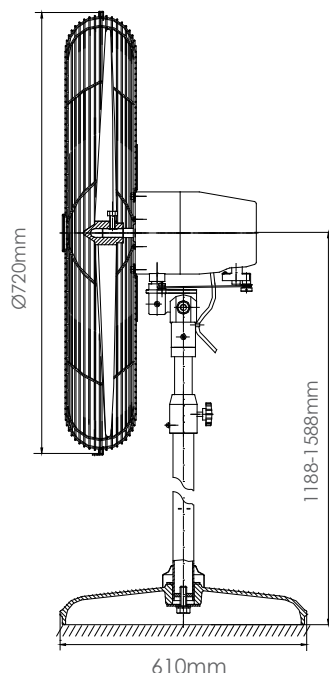

NB - To be installed by a qualified electrician.